

The information disclosed herein is the property of the originator who reserves all patent, design, proprietary, manufacturing, use and sales rights thereto, except for the rights expressly granted to others. This document shall not be reproduced nor shall the information contained within be used by or disclosed to others except as expressly authorized by the originator. ©

Revision Letter	Change Description	
A	Corrected -03 Upper Firewall to show that top rivet is left out until a later assembly.	09.19.2016
B	Added upper pilot and corner clearance notches to parts -03R and -03L. Added second row of pilot holes to -01. Installed rivet in top hole of -03 Assembly Corrected "Left" and "Right" hand callouts on -03.	12.02.2016

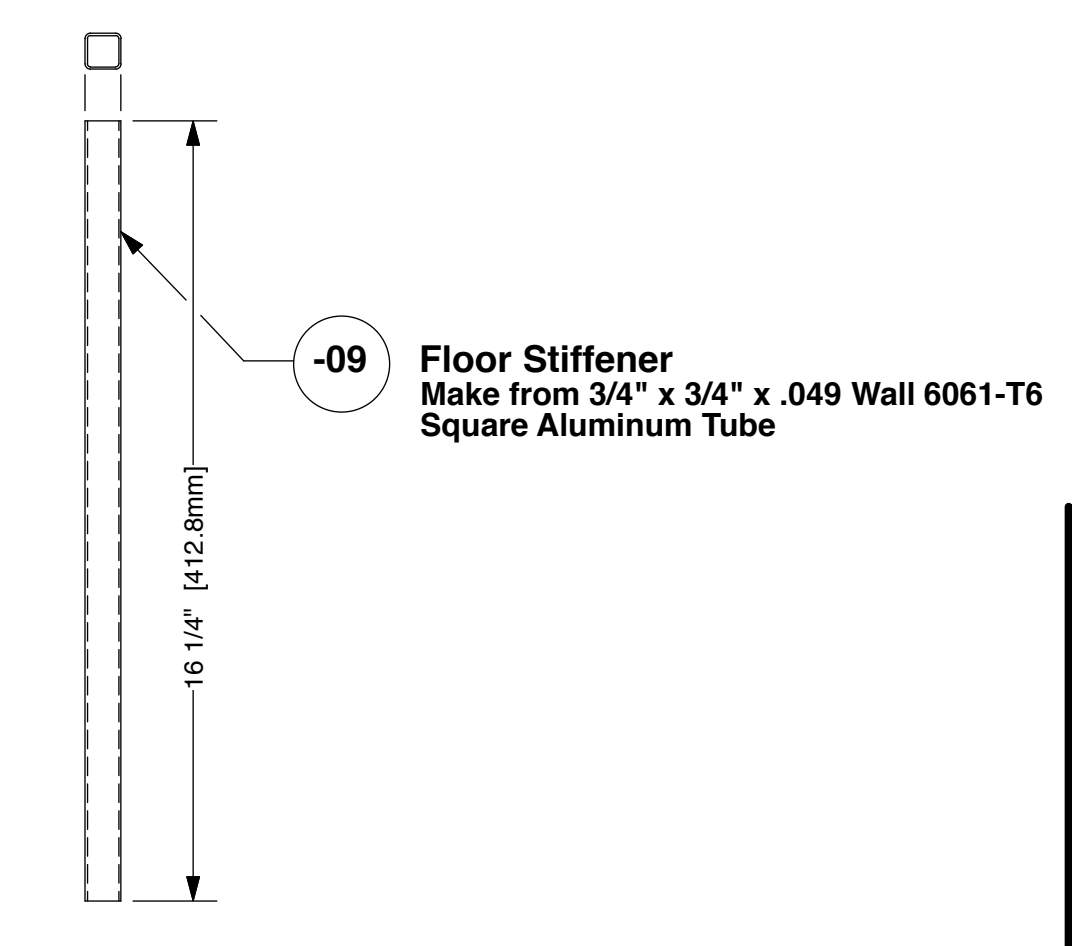
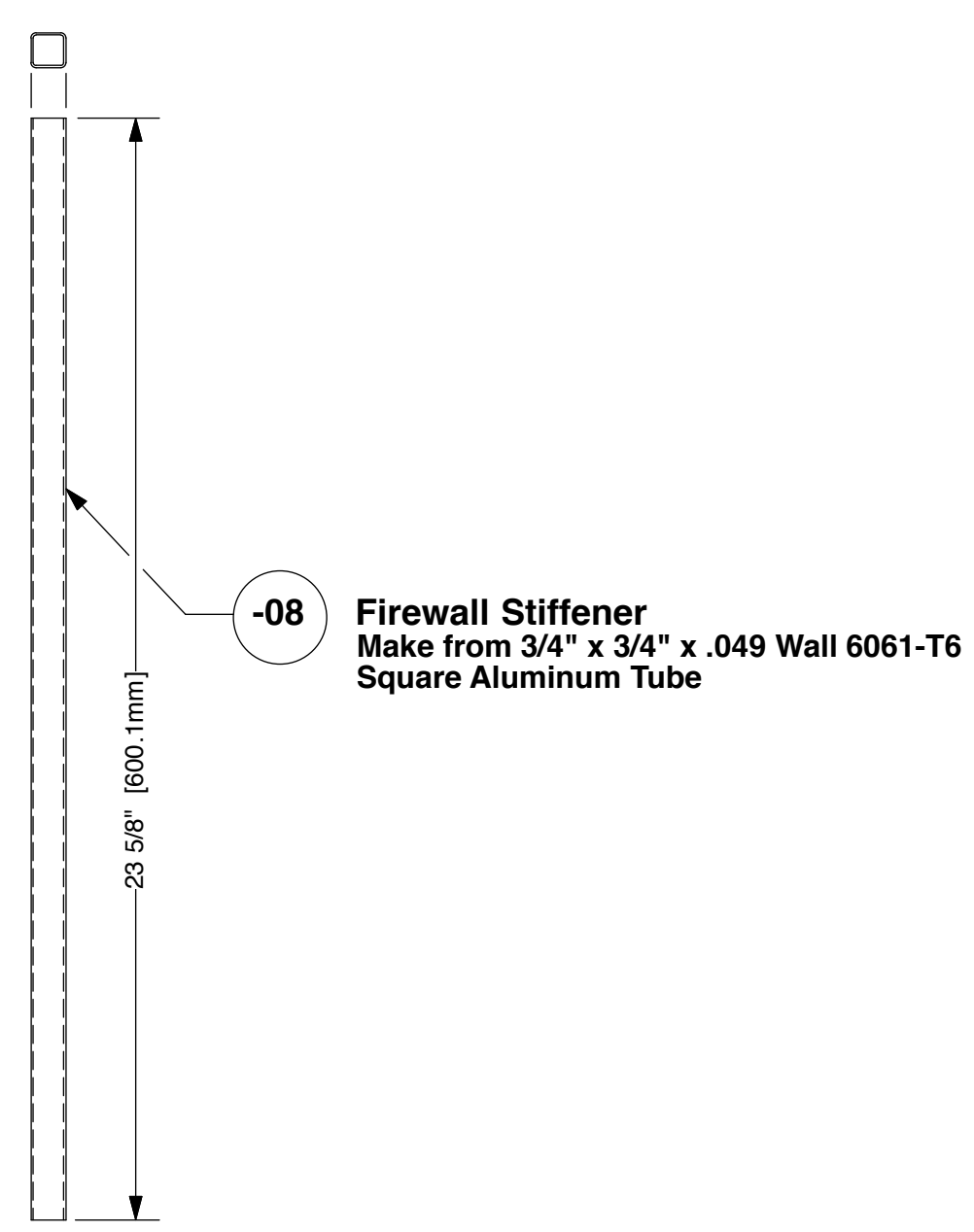
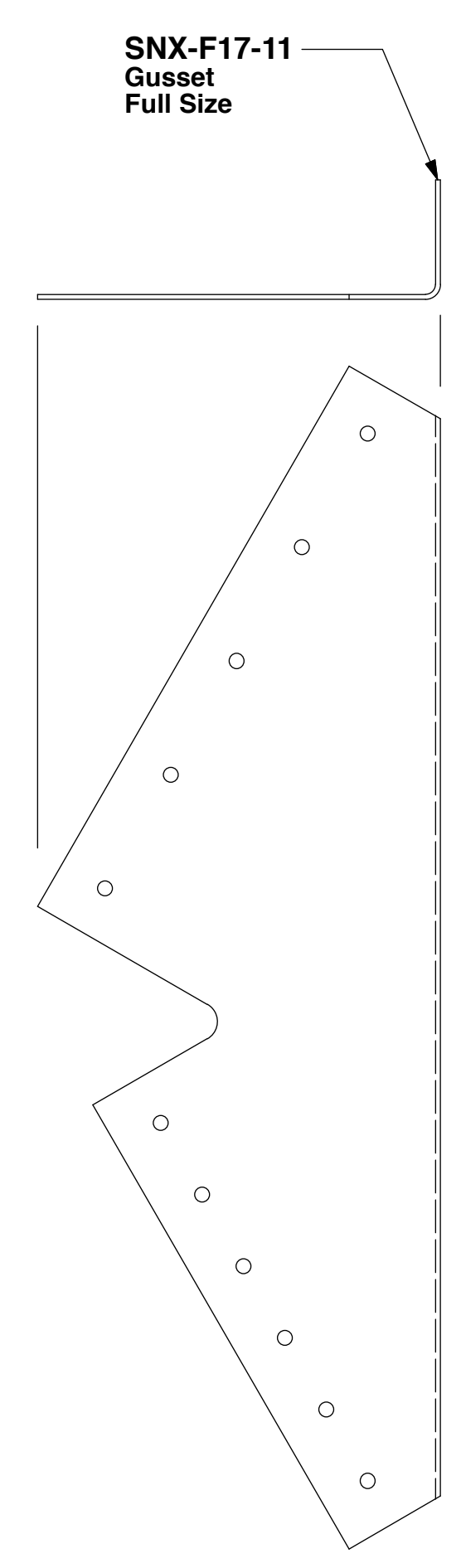
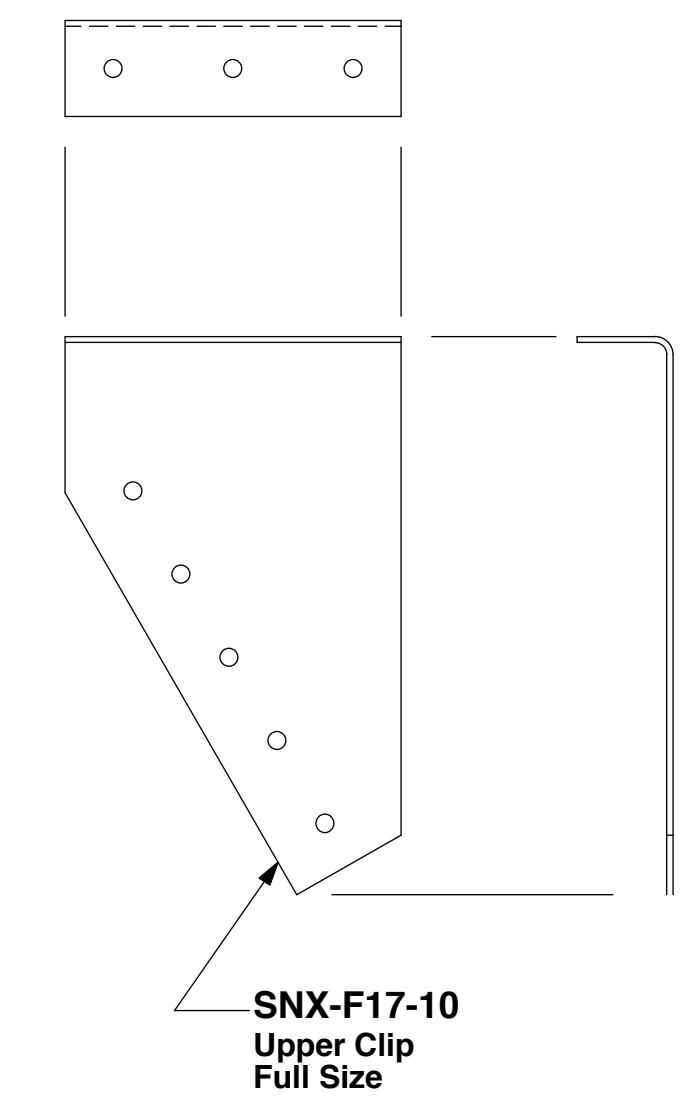
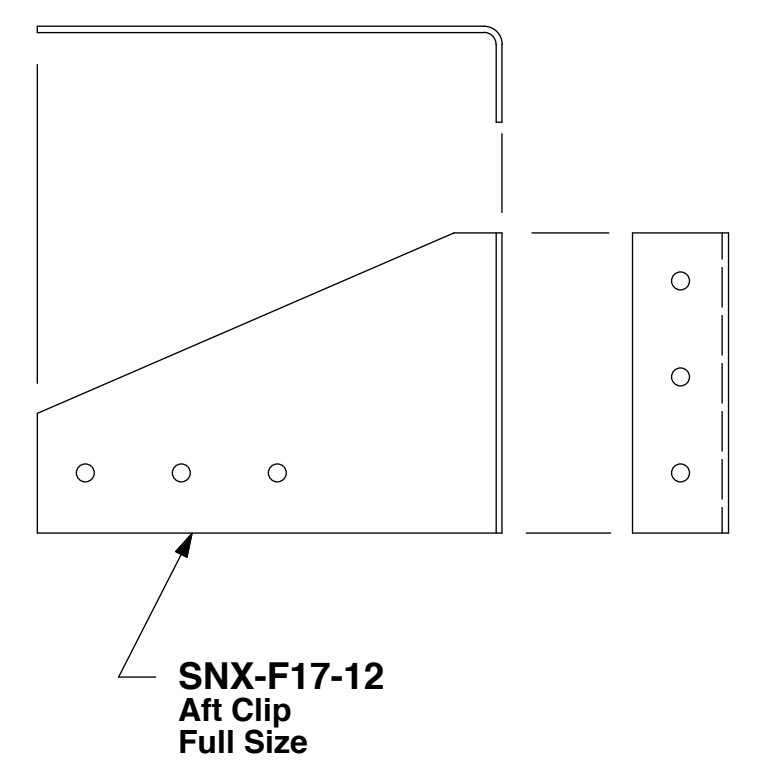
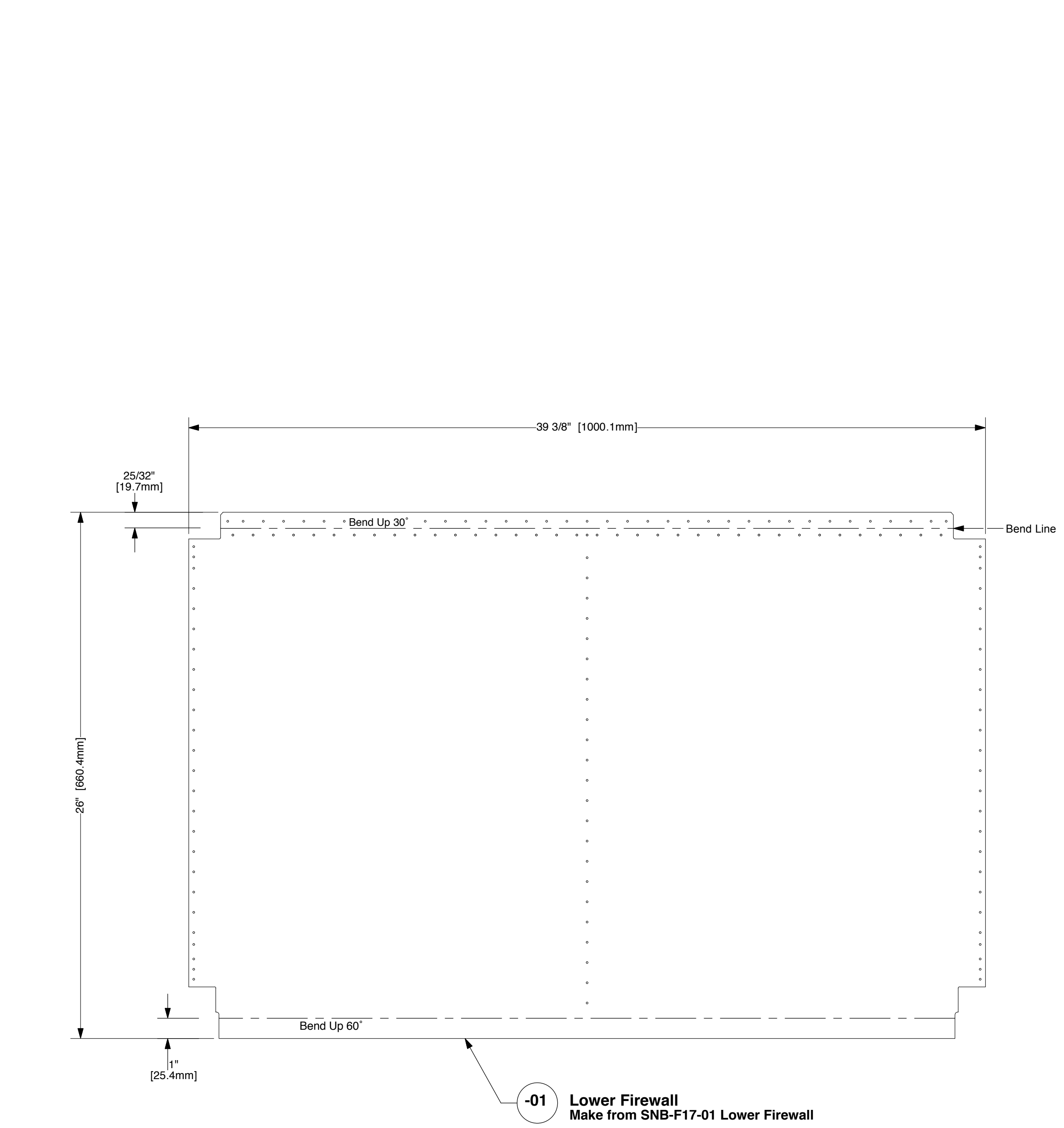
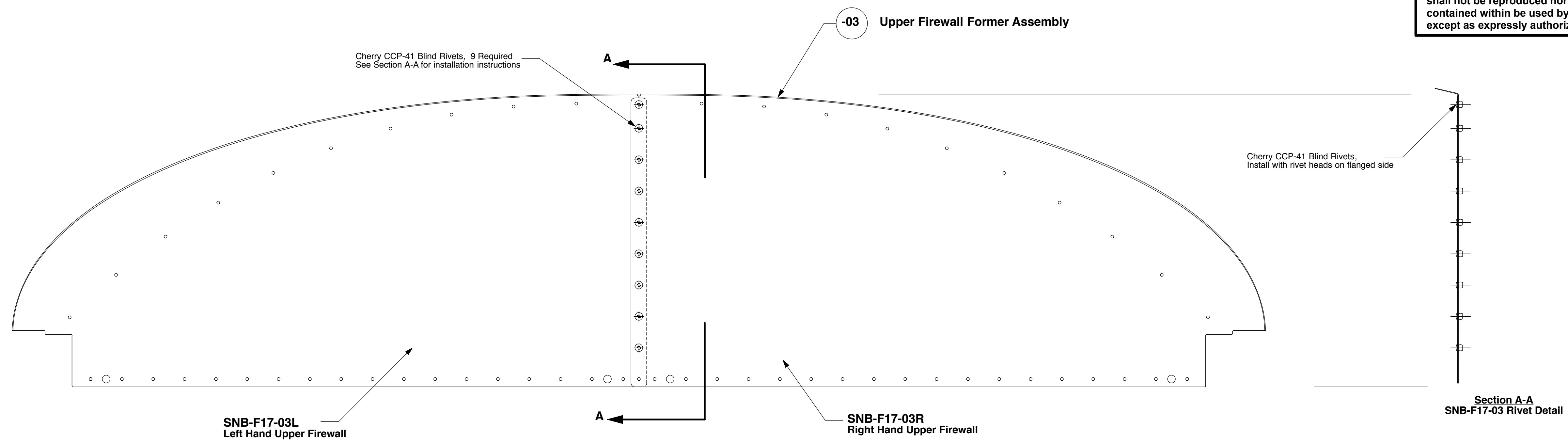

SNX-F17-12	1	Aft Clip	SNB-F11
SNX-F17-11	1	Gusset	SNB-F11
SNX-F17-10	1	Upper Clip	SNB-F11
SNB-F17-09	1	Floor Stiffener	SNB-F11
SNB-F17-08	1	Firewall Stiffener	SNB-F11
SNB-F17-03	1	Upper Firewall Assembly	SNB-F11
SNB-F17-01	1	Lower Firewall	SNB-F11
Part / Ass'y Number	Qty. Req'd	Part Title	Next Assembly

sonex-B
Fuselage Firewall and Misc. Details

Drawing Scale 1/4 & Noted	Drawing Number SNB-F17	Revision B
------------------------------	---------------------------	---------------